

photomultiplier HV base

HV38K20AP series data sheet

1 description

The HV38K20AP is a compact photomultiplier HV Base operating from a low voltage supply (+5 to +15 V). It incorporates a positive HV supply and an active MOSFET voltage divider. The HV Base is intended for use with all 10-stage, 38 mm capped base photomultipliers for applications requiring up to +2000 volts and ac coupling.

The unit is housed in a screened cylindrical metal enclosure of the same diameter as the photomultiplier (38 mm). Threaded mounting bushes are provided. The signal is accessible via a 0.5 m length of shielded RG174U cable and is ac coupled.

The photomultiplier operating voltage is set by using any one of three programming options as shown in section 8. The cathode connection is at ground potential in the HV38K20AP but for applications requiring grounded anode operation, a negative polarity version is available, which is the HV38K20AN series.

2 applications

The HV38K20AP is designed for use in the following operating modes:

- pulsed light
- photon counting

3 features

- compact
- no high voltage cables
- low noise
- linearity limited only by photomultiplier performance
- low power consumption

4 specifications

at HV = 1000V	unit	min	typ	max
supply voltage	V	+5		+15
control voltage	V	+0.1		+2.0
output high voltage	V	+100		+2000
output (anode) current	μA			200*
supply current at +5 V; for anode current = 0 μA	mA		70	
for anode current = 100 μA	mA		150	
supply current at +12 V: for anode current = 0 μA	mA		40	
for anode current = 100 μA	mA		60	
line regulation	%/V			0.01
anode load regulation: for anode current 0 - 100 μA	%			0.01
temperature coefficient	%/°C			0.02
switch-on time (10 - 90%)	s		0.2	
switch-off time (90 - 10%)	s		3	
anode ripple: for anode load = 10 kΩ 22pF	mV(p-p)		2	
weight	g		50	

*Subject to photomultiplier limit

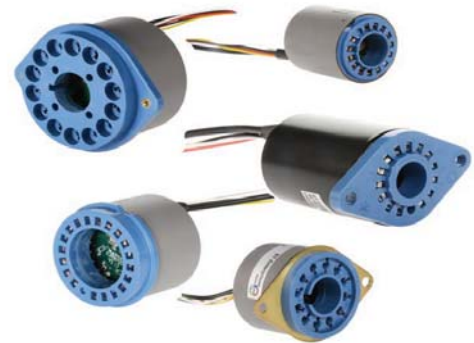

5 ratings

	unit	min	typ	max
supply voltage	V	4.5		18
control voltage	V	0		3
temperature (operating): at 93% RH, non-condensing	°C	-40		60

6 schematic diagram

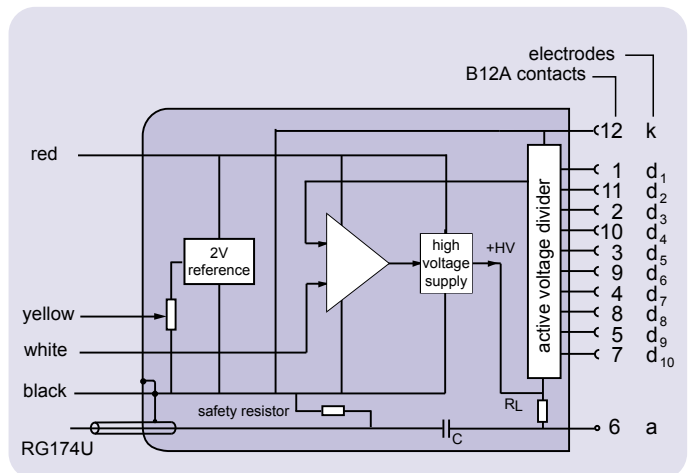

7 voltage distribution

The photomultiplier pin configuration for this HV base is given below. The voltage distribution for an applied HV of V volts is shown in the table. Note that an anode load resistor (R_L) of 100 KΩ is included. A 10 MΩ safety resistor and capacitor, C, are connected between anode and ground to maintain the output at 0 V.

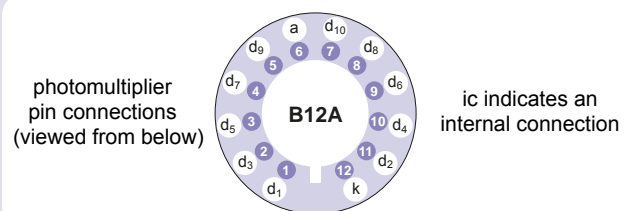

k	d ₁	d ₂	d ₉	d ₁₀	a
2/12V	1/12V	1/12V	1/12V		

8 programming options

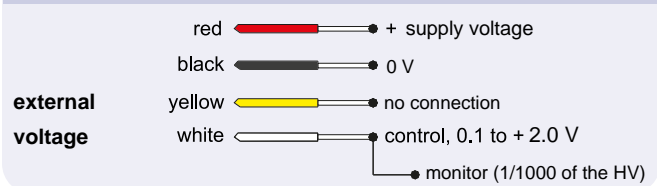
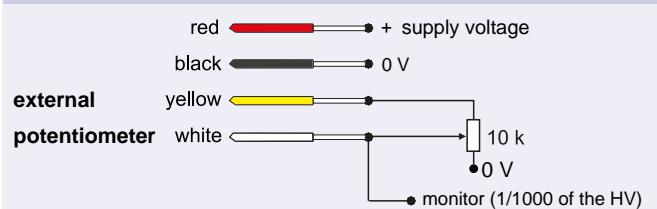
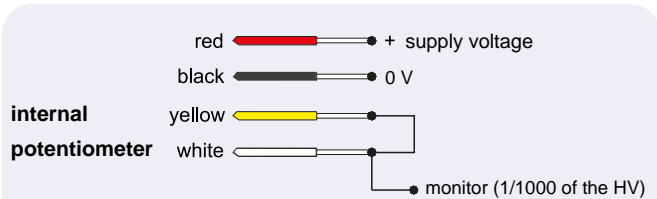

9 dimensions and photomultiplier options

The HV38K20AP series HV base can be used with the following photomultipliers:

9102KB, 9845KB, 9902KB, 9903KB, 9972KB,

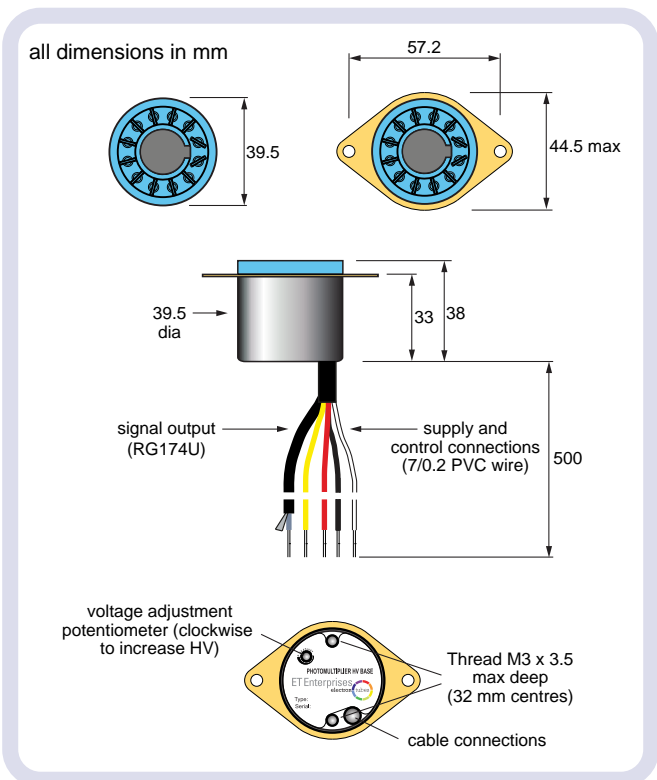

10 linearity

Linearity performance is dependent on the particular photomultiplier being used with the HV Base. It is measured as the % deviation in either peak pulse current, or average current, depending on the mode of operation.

Please refer to the corresponding photomultiplier data sheet for further information.

11 output configuration

The photomultiplier anode is internally ac coupled to ground via a 10 MΩ safety resistor. An internal load resistor, R_L (int), of 100 KΩ is also provided. An external load resistor, R_L , can be added if required.

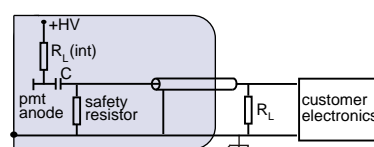

C = internal coupling capacitor
 R_L (int) = internal load resistor
 R_L = external load resistor (optional)

12 ordering information

item	ordering code
without flange	HV38K20AP
with flange	HV38K20APF

13 warning

High voltages generated by these products present an electrical shock hazard and appropriate precautions must be taken.

Installation must be by qualified personnel.

All units are despatched with the internal potentiometer set to zero.

Do not operate outside the quoted ratings of the HV38K20AP or those of the photomultiplier. This may result in loss of performance, permanent damage, or both.

ET Enterprises Limited
45 Riverside Way
Uxbridge UB8 2YF
United Kingdom
tel: +44 (0) 1895 200880
fax: +44 (0) 1895 270873
e-mail: sales@et-enterprises.com
web site: www.et-enterprises.com

ADIT Electron Tubes
300 Crane Street
Sweetwater TX 79556 USA
tel: (325) 235 1418
toll free: (800) 399 4557
fax: (325) 235 2872
e-mail: sales@electron tubes.com
web site: www.electrontubes.com

an ISO 9001 and ISO 14001 registered company

The company reserves the right to modify these designs and specifications without notice. Developmental devices are intended for evaluation and no obligation is assumed for future manufacture. While every effort is made to ensure accuracy of published information the company cannot be held responsible for errors or consequences arising therefrom.

