

photomultiplier HV Base

HV3020AN series data sheet

1 description

The HV3020AN is a compact power efficient photomultiplier HV Base operating from a low voltage supply (+5 to +15 V). It incorporates a negative HV supply and an active MOSFET voltage divider. The HV Base is suitable for most 11-stage, 30 mm, hardpin photomultipliers for applications requiring up to -2000 volts and ac or dc coupling.

The unit is housed in a screened cylindrical metal enclosure of the same diameter as the photomultiplier (30 mm). Threaded mounting bushes are provided. The anode output is via a 0.5 m length of shielded RG174U cable and can be ac or dc coupled.

The photomultiplier operating voltage is set by using any one of three programming options as shown in section 8. The anode is at ground potential in the HV3020AN but for applications requiring grounded cathode operation, a positive polarity version is available, which is the HV3020AP.

2 applications

The HV3020AN is designed for use in the following operating modes:

- current measurement (analogue)
- pulsed light
- photon counting

3 features

- compact
- no high voltage cables
- low noise
- linearity limited only by photomultiplier performance
- low power consumption

4 specifications

at HV = 1000V	unit	min	typ	max
supply voltage	V	+5		+15
control voltage	V	+0.1		+2.0
output high voltage	V	-100		-2000
output (anode) current	μA			200*
supply current at +5 V;				
for anode current = 0 μA	mA		70	
for anode current = 100 μA	mA		150	
supply current at +12 V:				
for anode current = 0 μA	mA		40	
for anode current = 100 μA	mA		60	
line regulation	%/V			0.01
anode load regulation:				
for anode current 0 - 100 μA	%			0.01
temperature coefficient	%/°C			0.02
switch-on time (10 - 90%)	s		0.2	
switch-off time (90 - 10%)	s		3	
anode ripple:				
for anode load = 10 kΩ 22pF	mV(p-p)		1	
weight	g		40	

*subject to photomultiplier limit



5 ratings

	unit	min	typ	max
supply voltage	V	4.5		18
control voltage	V	0		3
temperature (operating): at 93% RH, non-condensing	°C	-40		60

6 schematic diagram

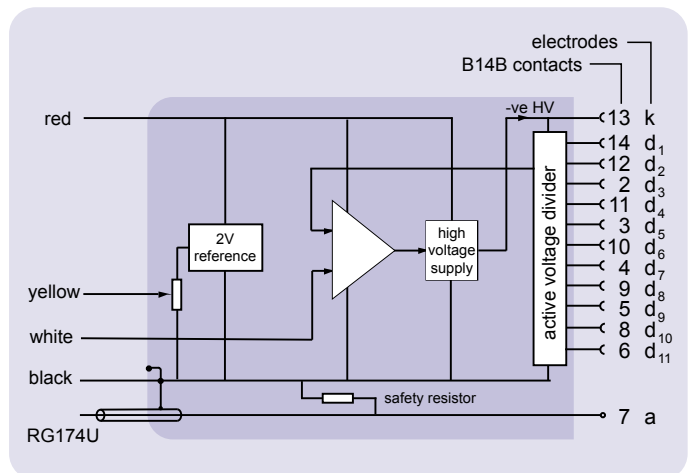

7 voltage distribution

The required photomultiplier pin configuration for this HV Base and a B14B socket is given below. The voltage distribution for an applied HV of V volts is shown in the table. An anode load resistor is not included but a 10MΩ safety resistor is connected between anode and ground to ensure that the output is kept at 0V.

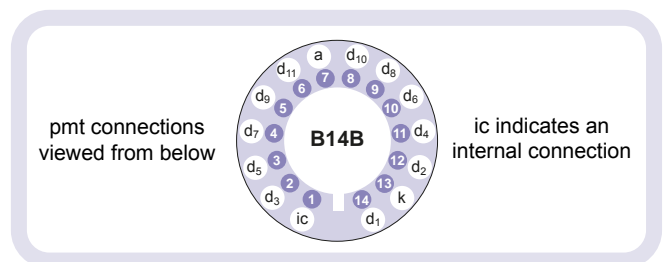

k	d ₁	d ₂	d ₁₀	d ₁₁	a
	2/13V	1/13V	1/13V	1/13V	

8 programming options

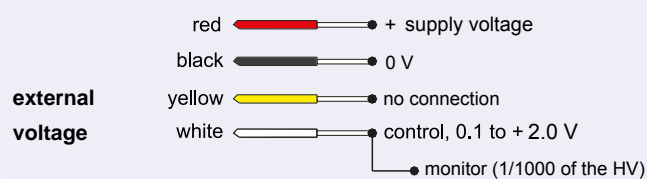
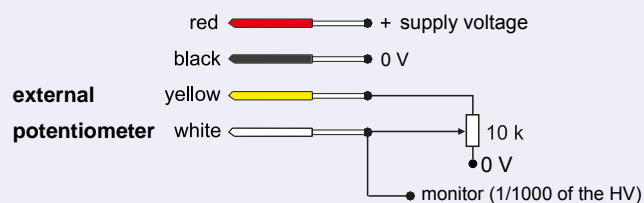
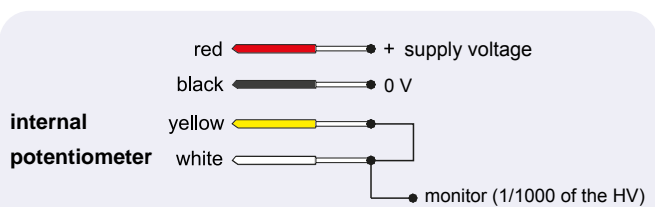

9 dimensions and photomultiplier options

The HV3020AN HV Base can be used with the following photomultipliers:

9107B, 9108B, 9124B, 9125B, 9128B, 9129B, 9130/100B, 9130/350B, 9131/100B, 9136B, 9142B, 9143B, 9442B, 9406B, 9407B, 9408B, 9798B, 9828B, 9900B and 9924B

all dimensions in mm

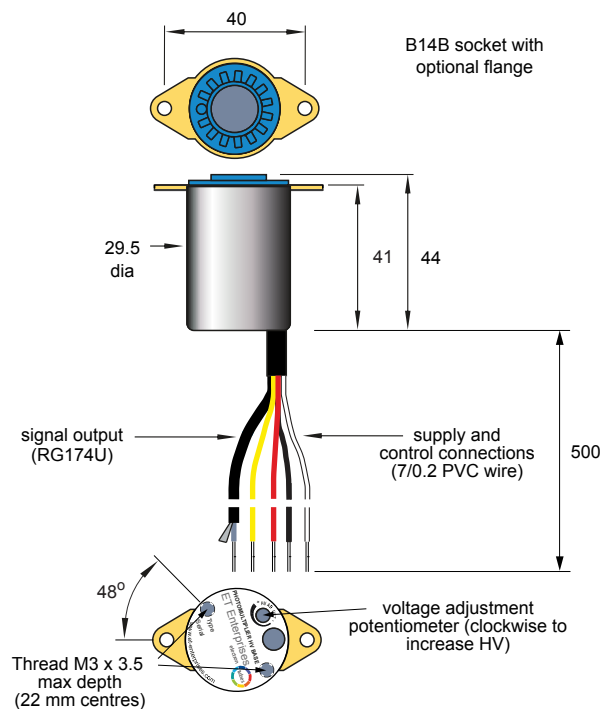

10 linearity

Linearity performance is dependent on the particular photomultiplier being used with the HV Base. It is measured as the % deviation in either peak pulse current, or average current, depending on the mode of operation.

Please refer to the corresponding photomultiplier data sheet for further information.

11 output configurations

The pmt anode in the HV3020AN HV Base is internally grounded via a 10 MΩ safety resistor. Depending on the mode of operation, the output circuitry should be configured externally as shown in the example configurations below. For dc and scintillation applications R_L is typically 100 kΩ, but for fast pulse applications R_L would normally be 50 Ω. In the latter case an internal 50 Ω matching resistor can be fitted (to special order).

a) dc current output

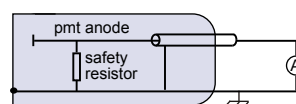

b) dc voltage output

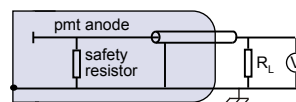

c) ac coupled output

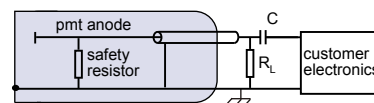

C = external coupling capacitor
 R_L = external load resistor

12 ordering information

item	ordering code
without flange	HV3020AN
with flange	HV3020ANF

13 warning

High voltages generated by these products present an electrical shock hazard and appropriate precautions must be taken.

Installation must be by qualified personnel.

All units are despatched with the internal potentiometer set to zero.

Do not operate outside the quoted ratings of the HV3020AN or those of the photomultiplier. This may result in loss of performance, permanent damage, or both.

ET Enterprises Limited
45 Riverside Way
Uxbridge UB8 2YF
United Kingdom
tel: +44 (0) 1895 200880
fax: +44 (0) 1895 270873
e-mail: sales@et-enterprises.com
web site: www.et-enterprises.com

ADIT Electron Tubes
300 Crane Street
Sweetwater TX 79556 USA
tel: (325) 235 1418
toll free: (800) 399 4557
fax: (325) 235 2872
e-mail: sales@electron tubes.com
web site: www.electrontubes.com

an ISO 9001 and ISO 14001 registered company

The company reserves the right to modify these designs and specifications without notice. Developmental devices are intended for evaluation and no obligation is assumed for future manufacture. While every effort is made to ensure accuracy of published information the company cannot be held responsible for errors or consequences arising therefrom.

ET Enterprises
electron tubes

© ET Enterprises Ltd, 2018
DS_ HV3020AN Issue 3 (23/07/18)