

# photomultiplier HV Base

## HV2520AP series data sheet

### 1 description

The HV2520AP is a compact power efficient photomultiplier HV Base operating from a low voltage supply (+5 to +15 V). It incorporates a positive HV supply and an active MOSFET voltage divider. The HV Base is intended for use with most 10-stage, 25 mm hardpin photomultipliers for applications requiring up to +2000 volts and ac coupling.

The unit is housed in a screened cylindrical metal enclosure with threaded mounting bushes. The anode output is via a 0.5 m length of shielded RG174U cable and is ac coupled.

The photomultiplier operating voltage is set by using any one of three programming options as shown in section 8. The cathode is at ground potential in the HV2520AP but for applications requiring grounded anode operation, a negative polarity version is available, which is the HV2520AN series.

### 2 applications

The HV2520AP is designed for use in the following operating modes:

- pulsed light
- photon counting

### 3 features

- compact
- no high voltage cables
- low noise
- linearity limited only by photomultiplier performance
- low power consumption

### 4 specifications

at HV = 1000V	unit	min	typ	max
<b>supply voltage</b>	V	+5		+15
<b>control voltage</b>	V	+0.1		+2.0
<b>output high voltage</b>	V	+100		+2000
<b>output (anode) current</b>	μA			200*
<b>supply current at +5 V;</b> for anode current = 0 μA	mA		70	
for anode current = 100 μA	mA		150	
<b>supply current at +12 V:</b> for anode current = 0 μA	mA		40	
for anode current = 100 μA	mA		60	
<b>line regulation</b>	%/V			0.01
<b>anode load regulation:</b> for anode current 0 - 100 μA	%			0.01
<b>temperature coefficient</b>	%/°C			0.02
<b>switch-on time (10 - 90%)</b>	s		0.2	
<b>switch-off time (90 - 10%)</b>	s		3	
<b>anode ripple:</b> for anode load = 10 kΩ    22pF	mV(p-p)		2.5	
<b>weight</b>	g		60	

\*subject to photomultiplier limit



### 5 ratings

	unit	min	typ	max
<b>supply voltage</b>	V	4.5		18
<b>control voltage</b>	V	0		3
<b>temperature (operating):</b> at 93% RH, non-condensing	°C	-40		60

### 6 schematic diagram

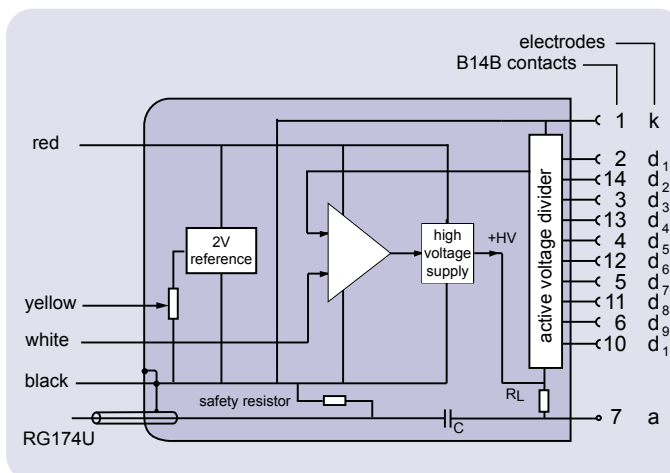

### 7 voltage distribution

The photomultiplier pin configuration for this HV Base and a B14B socket is given below. The voltage distribution for an applied HV of V volts is shown in the table. Note that an anode load resistor ( $R_L$ ) of 100 KΩ is included. A 10 MΩ safety resistor and capacitor, C, are connected between anode and ground to maintain the output at 0 V.

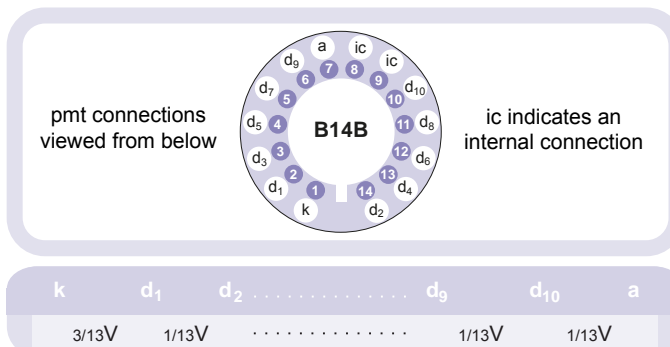

## 8 programming options

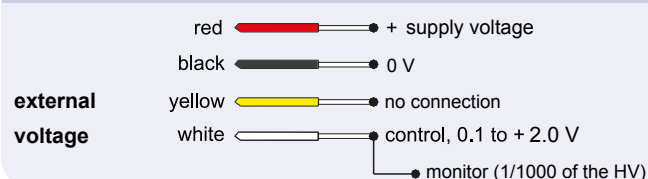
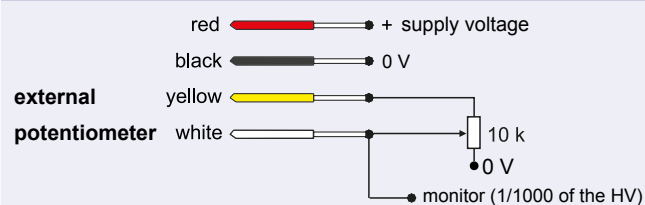
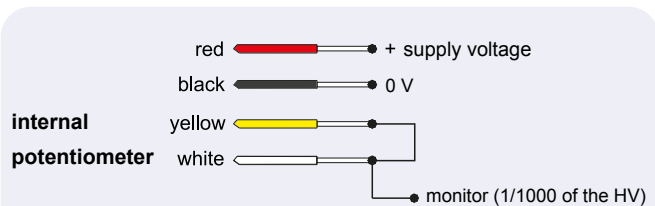

## 9 dimensions and photomultiplier options

The HV2520AP HV Base can be used with the following photomultipliers:

9111B, 9112B, 9113B and 9114B

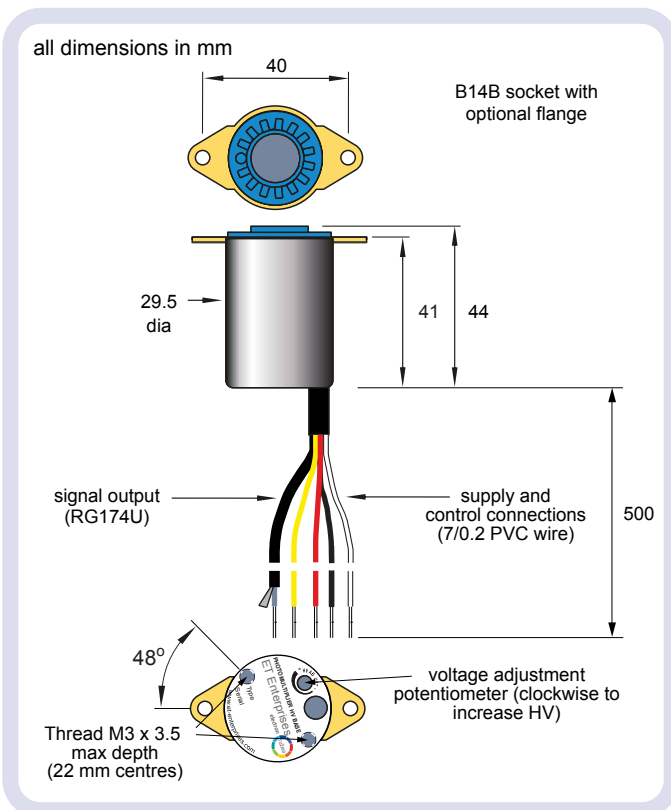

## 10 linearity

Linearity performance is dependent on the particular photomultiplier being used with the HV Base. It is measured as the % deviation in either peak pulse current, or average current, depending on the mode of operation.

Please refer to the corresponding photomultiplier data sheet for further information.

## 11 output configuration

The photomultiplier anode is internally ac coupled to ground via a 10 MΩ safety resistor. An internal load resistor,  $R_L$  (int), of 100 KΩ is also included. An external load resistor,  $R_L$ , can be added if required.

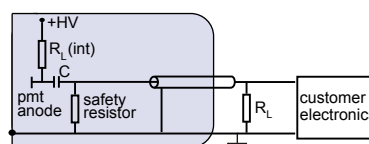

C = internal coupling capacitor  
 $R_L$  (int) = internal load resistor  
 $R_L$  = external load resistor (optional)

## 12 ordering information

item	ordering code
without flange	HV2520AP
with flange	HV2520APF

## 13 warning

High voltages generated by these products present an electrical shock hazard and appropriate precautions must be taken.

Installation must be by qualified personnel.

All units are despatched with the internal potentiometer set to zero.

Do not operate outside the quoted ratings of the HV2520AP or those of the photomultiplier. This may result in loss of performance, permanent damage, or both.

**ET Enterprises Limited**  
45 Riverside Way  
Uxbridge UB8 2YF  
United Kingdom  
tel: +44 (0) 1895 200880  
fax: +44 (0) 1895 270873  
e-mail: sales@et-enterprises.com  
web site: www.et-enterprises.com

**ADIT Electron Tubes**  
300 Crane Street  
Sweetwater TX 79556 USA  
tel: (325) 235 1418  
toll free: (800) 399 4557  
fax: (325) 235 2872  
e-mail: sales@electron tubes.com  
web site: www.electrontubes.com

an ISO 9001 and ISO 14001 registered company

The company reserves the right to modify these designs and specifications without notice. Developmental devices are intended for evaluation and no obligation is assumed for future manufacture. While every effort is made to ensure accuracy of published information the company cannot be held responsible for errors or consequences arising therefrom.

